









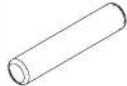

(1) Top	(2) End Panel	(3) End Panel	(4) Modesty Panel	(5) End Panel	(A) Dowel	(B) Cam Pin	(C) Cam Lock	(D) Cam Cover	(E) Leg leveller	(F) Grommet
										
1PCS	1PCS	1PCS	1PCS	1PCS	16PCS+1	14PCS+1	14PCS+1	14PCS+1	5PCS	4PCS

STEP 1



STEP 2

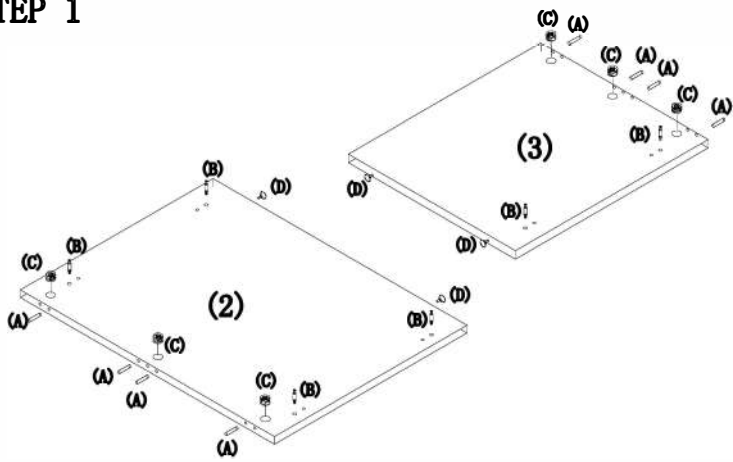
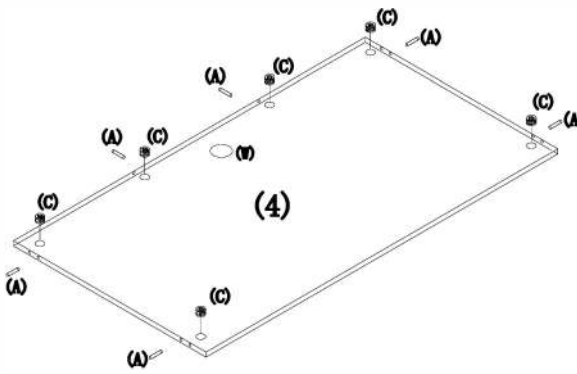

STEP 4

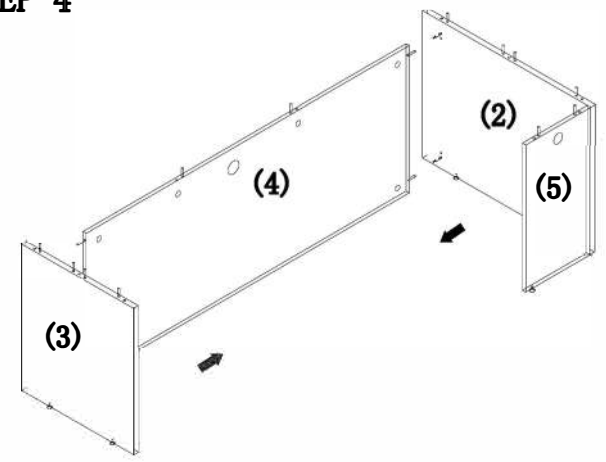

STEP 3



STEP 6

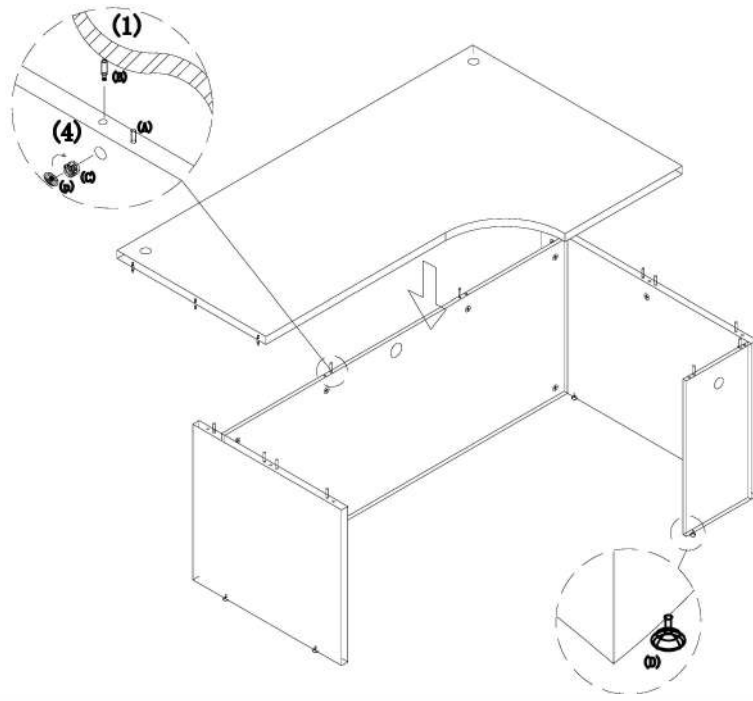

STEP 5

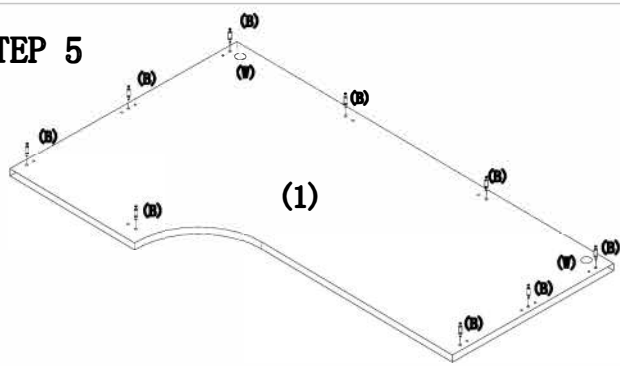

CORNER CREDENZA R
NAP-82R
 70"W*35"D*29"H



Always lay components on A clean, soft-cushioned surface during assembly.